

Durchbohrte Schrauben Cannulated Screws

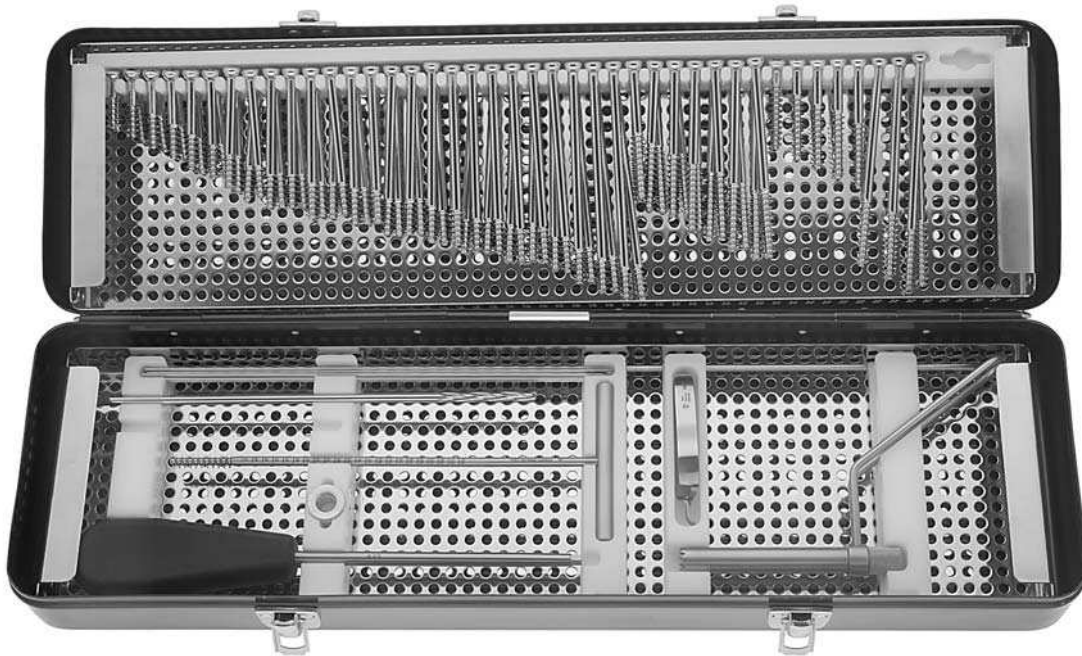

Cannulated Screws and Instrument Set



- T 500 Cannulated Screws and Instrument Set
- T 19E-286.03 Aluminium Case
- T 501 Upper Tray
- T 502 Lower Tray

			pieces
5-002-	Hollow Screws 7.0 mm \varnothing , 16 mm		
5-009	30-35-40-45-50-55-60-65 mm	ea. 2	16
5-010-	Hollow Screws 7.0 mm \varnothing 16 mm		
5-016	70-75-80-85-90-95-100 mm	ea. 4	28
5-017-	Hollow Screws 7.0 mm \varnothing 16 mm		
5-020	105-110-115-120 mm	ea. 2	8
5-031-	Hollow Screws 7.0 mm \varnothing 32 mm		
5-035	45-50-55-60-65 mm	ea. 1	5
5-036-	Hollow Screws 7.0 mm \varnothing 32 mm		
5-042	70-75-80-85-90-95-100 mm	ea. 2	14
5-043-	Hollow Screws 7.0 mm \varnothing 32 mm		
5-046	105-110-115-120 mm	ea. 1	4
5-132	Washer 19 mm \varnothing		6
	1 Tray		
5-100	Drill Bit 5.0 mm \varnothing		1
5-114	Tap 7.0 mm \varnothing		1
5-118	Screw Driver		1
5-130	Tissue Protector Sleeve		1
5-140	Guide Wire 2.0 mm \varnothing 230 mm		10
4-184	Screw Holding Forceps		1
5-160	Direct Screws Length Gauge for \varnothing 7.0 mm		1

Cannulated Screws



7 mm \varnothing with over flats SW 5.0 mm
16 mm length of thread, drill bit 5.0 mm

5-001	25 mm	5-011	75 mm
5-002	30 mm	5-012	80 mm
5-003	35 mm	5-013	85 mm
5-004	40 mm	5-014	90 mm
5-005	45 mm	5-015	95 mm
5-006	50 mm	5-016	100 mm
5-007	55 mm	5-017	105 mm
5-008	60 mm	5-018	110 mm
5-009	65 mm	5-019	115 mm
5-010	70 mm	5-020	120 mm



7 mm \varnothing with over flats SW 5.0 mm
32 mm length of thread, drill bit 5.0 mm

5-030	40 mm	5-040	90 mm
5-031	45 mm	5-041	95 mm
5-032	50 mm	5-042	100 mm
5-033	55 mm	5-043	105 mm
5-034	60 mm	5-044	110 mm
5-035	65 mm	5-045	115 mm
5-036	70 mm	5-046	120 mm
5-037	75 mm		
5-038	80 mm		
5-039	85 mm		



Guide Wire with 10 mm thread

5-140 Guide Wire 2.0 mm \varnothing for Hollow Screws 7 mm \varnothing 230 mm

Instruments for 7 mm Cannulated Screws



5-100 Drill Bit 5.0 mm ø

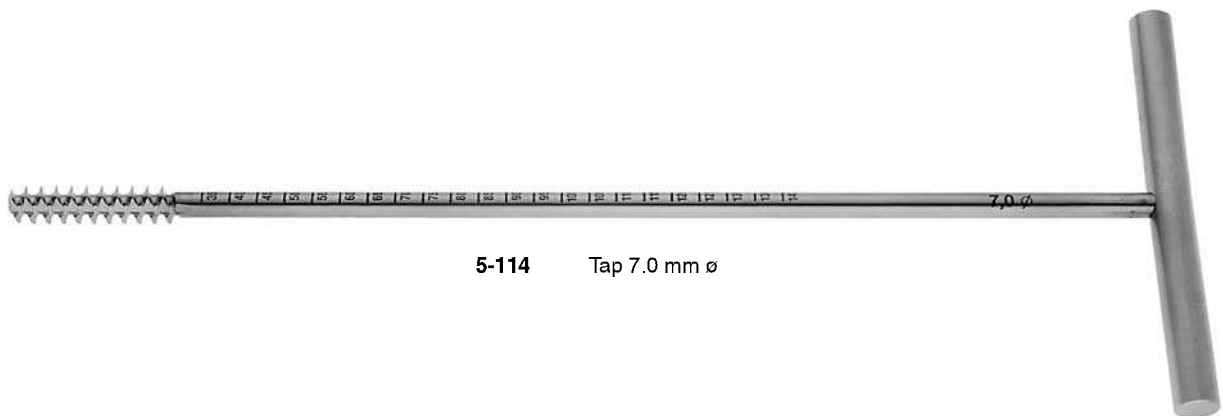

5-114 Tap 7.0 mm ø



5-118 5 mm Screw Driver for 7 mm screws

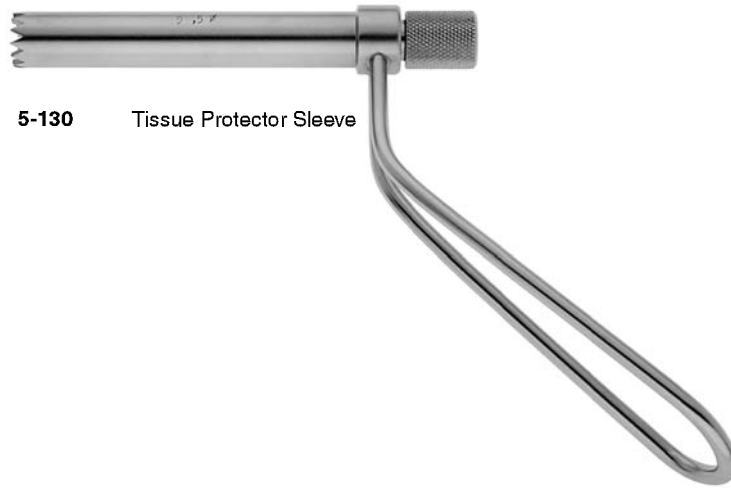

5-130 Tissue Protector Sleeve



Washers for Hollow Screws

5-132	19 mm \varnothing
5-134	16 mm \varnothing
5-522	13 mm \varnothing



5-131 Parallel Target Device for Guide Wires \varnothing 2.0 mm

Durchbohrte Schrauben Cannulated Screws

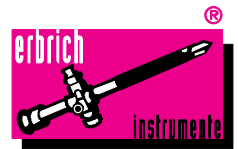

Cannulated Screws \varnothing 3.5 mm



Dia of thread	3.5 mm	3.5 mm
Width over flats	2.5 mm	2.5 mm
Drill Bit	2.7 mm	2.7 mm
Length		
10 mm	5-300	5-342
12 mm	5-302	5-344
14 mm	5-304	5-346
16 mm	5-306	5-348
18 mm	5-308	5-350
20 mm	5-310	5-352
22 mm	5-312	5-354
24 mm	5-314	5-356
26 mm	5-316	5-358
28 mm	5-318	5-360
30 mm	5-320	5-362
32 mm	5-322	5-364
34 mm	5-324	5-366
36 mm	5-326	5-368
38 mm	5-328	5-370
40 mm	5-330	5-372
42 mm	5-332	5-374
44 mm	5-334	5-376
46 mm	5-336	5-378
48 mm	5-338	5-380
50 mm	5-340	5-382

Guide Wire with 10 mm thread

5-138 Guide Wire 1.0 mm \varnothing for Hollow Screws 3.5 mm \varnothing 230 mm

Instruments for 3.5 mm Cannulated Screws

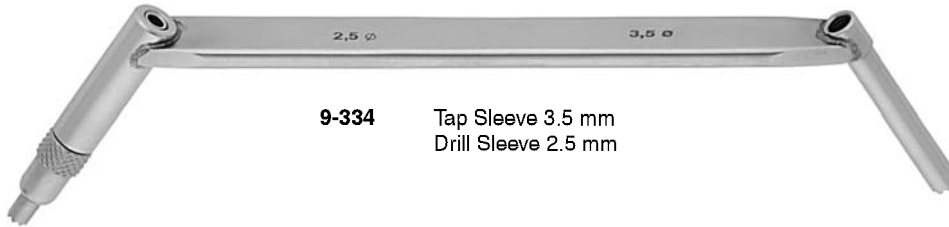

9-334 Tap Sleeve 3.5 mm
Drill Sleeve 2.5 mm

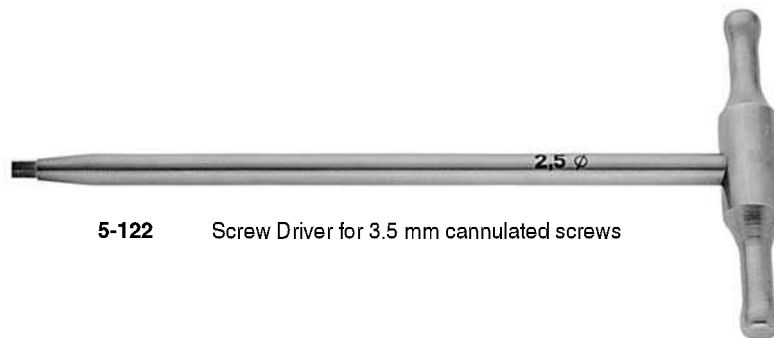

5-122 Screw Driver for 3.5 mm cannulated screws

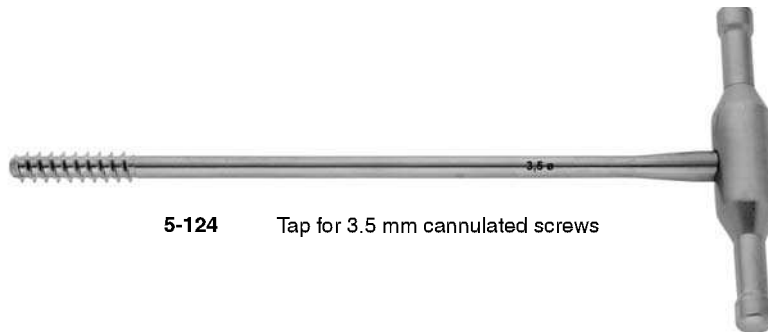

5-124 Tap for 3.5 mm cannulated screws



Cannulated Drill Bit 160 mm
length
5-098 Drill Bit ø 3.5 mm / 1.35 mm
5-099 Drill Bit ø 2.7 mm / 1.35 mm



5-126 Tap Sleeve 2.7 mm
Drill Sleeve 1.0 mm

Durchbohrte Schrauben Cannulated Screws

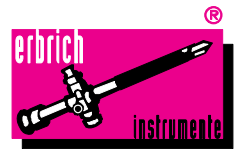

Cannulated Screws \varnothing 4.5 mm

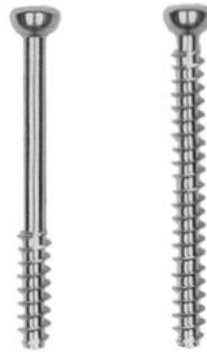

Dia of thread	4.5 mm	4.5 mm
Width over flats	3.5 mm	3.5 mm
Drill Bit	3.2 mm	3.2 mm
Length		
20 mm	5-200	5-230
22 mm	5-201	5-231
24 mm	5-202	5-232
26 mm	5-203	5-233
28 mm	5-204	5-234
30 mm	5-205	5-235
32 mm	5-206	5-236
34 mm	5-207	5-237
36 mm	5-208	5-238
38 mm	5-209	5-239
40 mm	5-210	5-240
42 mm	5-211	5-241
44 mm	5-212	5-242
46 mm	5-213	5-243
48 mm	5-214	5-244
50 mm	5-215	5-245
52 mm	5-216	5-246
54 mm	5-217	5-247
56 mm	5-218	5-248
58 mm	5-219	5-249
60 mm	5-220	5-250

Guide Wire with 10 mm thread

5-260 Guide Wire 1.6 mm \varnothing for Hollow Screws 7 mm \varnothing 230 mm

Instruments for 4.5 mm Cannulated Screws

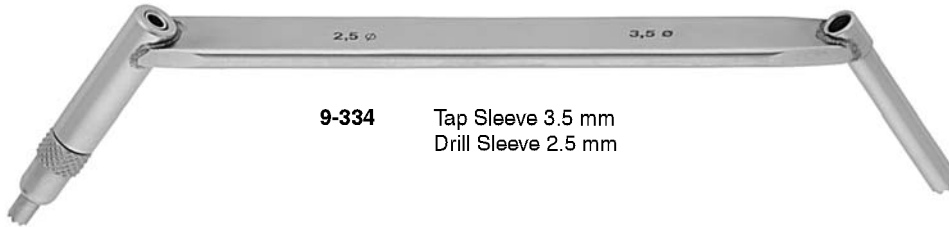

9-334 Tap Sleeve 3.5 mm
Drill Sleeve 2.5 mm



5-120 Screw Driver for 4.5 mm cannulated screws

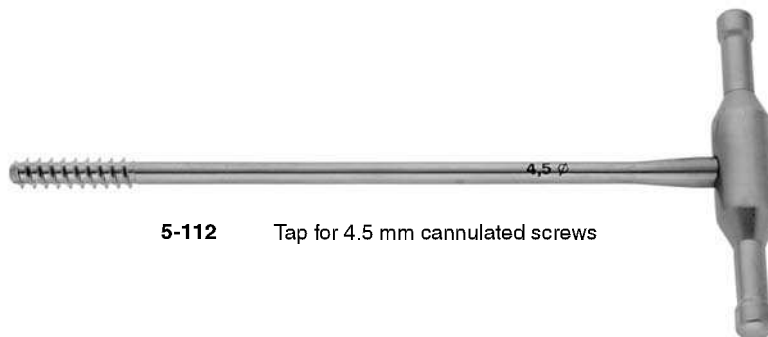

5-112 Tap for 4.5 mm cannulated screws



Cannulated Drill Bit 160 mm
length
5-142 Drill Bit \varnothing 4.5 mm / 1.75 mm
5-144 Drill Bit \varnothing 3.2 mm / 1.75 mm

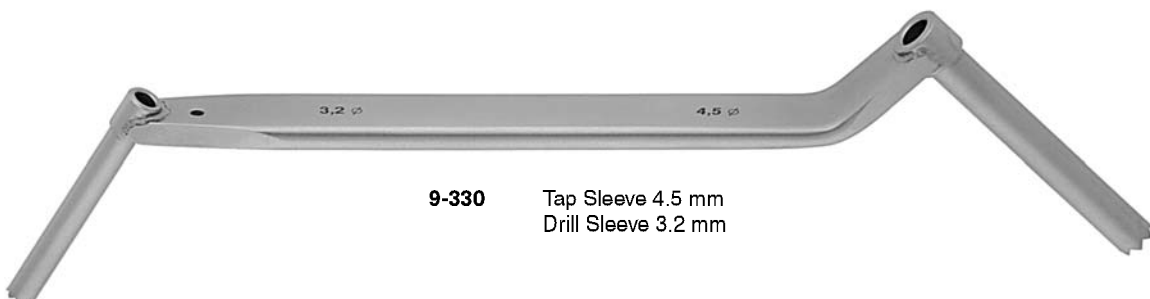

9-330 Tap Sleeve 4.5 mm
Drill Sleeve 3.2 mm

Instruments for cannulated Screws



5-160 Direct Screws Length Gauge for 7.0 mm ø

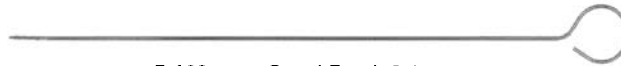

5-162 Canal Brush 2.1 mm ø

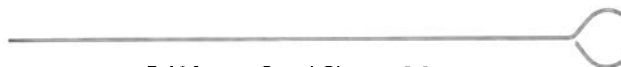

5-164 Canal Cleaner 2.0 mm ø



5-166 Direct Screws Length Gauge for 4.5 mm ø

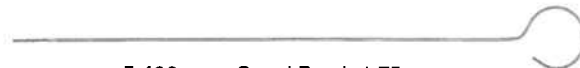

5-168 Canal Brush 1.75 mm ø

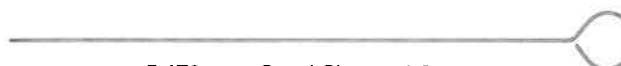

5-170 Canal Cleaner 1.6 mm ø



5-172 Direct Screws Length Gauge for 3.5 mm ø



5-174 Canal Brush 1.35 mm ø

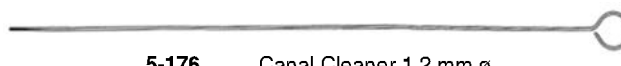

5-176 Canal Cleaner 1.2 mm ø



5-178 Holding Clamp

Knochenklammern Staples

Epiphyseal Staples Stainless Steel



- 5-600** Barbed Staples 8.7 x 16 x 2 mm
- 5-602** Barbed Staples 8.7 x 19 x 2 mm
- 5-604** Barbed Staples 8.7 x 22 x 2 mm
- 5-606** Barbed Staples 8.7 x 25 x 2 mm



5-610
24 x 33 x 4.8 mm



5-612
24 x 33 x 9.5 mm



5-614
24 x 33 x 14 mm



	Diameter	Width	Length
5-620	2.5 mm	22 mm	19 mm
5-622	2.5 mm	16 mm	19 mm
5-624	1.5 mm	22 mm	19 mm
5-626	1.5 mm	16 mm	19 mm

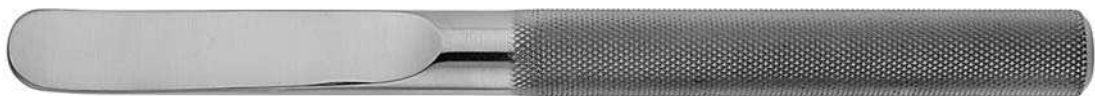

5-630 Staples Extractor



5-632 Staples Driver



5-634 Staples Inserter

Staples - Chrome Cobalt Molybden



5-650 6 mm



5-652 8 mm



5-654 11 mm

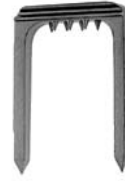

5-656 14 mm

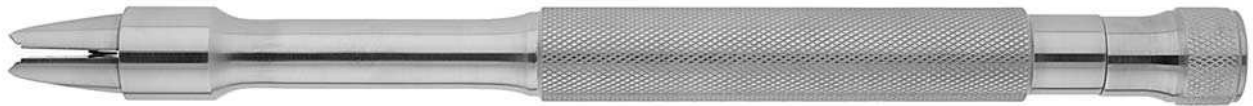

5-670 Impactor

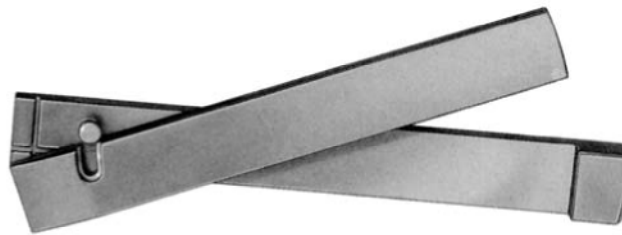

5-671 Impactor for 5-680 - 5-704
5-672 Impactor for 5-710 - 5-724



5-680
9.5 x 22 mm



5-682
16 x 22 mm



5-684
22 x 22 mm



5-686
28 x 22 mm

Chrome Cobalt Molybden Osteotomy Staples

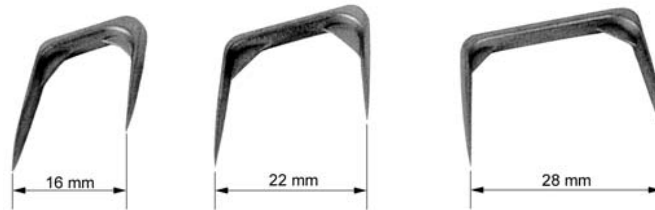

Cat. No.:	Width	Length
5-705	16 mm	22 mm
5-706	22 mm	22 mm
5-707	28 mm	22 mm

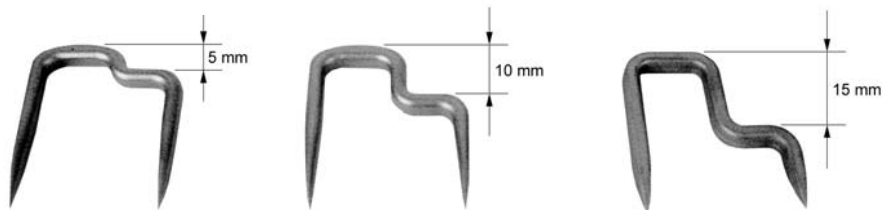

Cat. No.:	Width A	Length B	Height C
5-710	24 mm	30 mm	5 mm
5-712	24 mm	30 mm	10 mm
5-714	24 mm	30 mm	15 mm

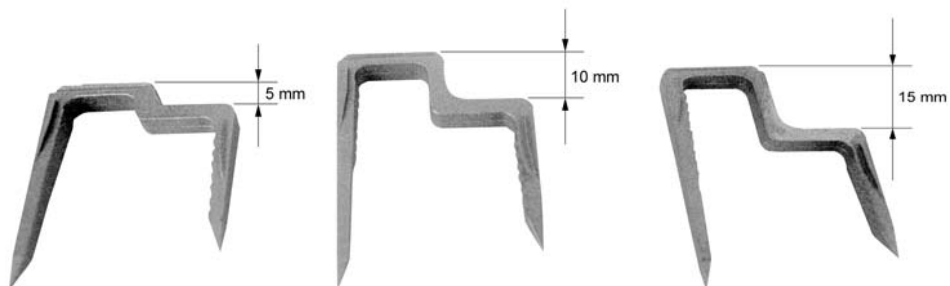

Cat. No.:	Width	Length	Height
5-730	24 mm	35 mm	5 mm
5-732	24 mm	40 mm	10 mm
5-734	24 mm	40 mm	15 mm

Knochenklammern Staples



Wilberg
5-750



Wilberg
5-752



Wilberg
5-754



Palmer
5-766



Palmer
5-768



Palmer

Cat. No.:	Length	Diam.
5-770	15 mm	1.5 mm
5-772	20 mm	1.5 mm
5-774	25 mm	1.5 mm
5-776	30 mm	1.5 mm
5-778	35 mm	1.5 mm
5-780	40 mm	1.5 mm
5-782	45 mm	1.5 mm
5-784	50 mm	1.5 mm
5-786	55 mm	1.5 mm
5-788	60 mm	1.5 mm
5-790	65 mm	1.5 mm
5-792	70 mm	1.5 mm

INTERFERENCE SCREW KREUZBANDSCHRAUBE



Cannulated Drill

5-950	∅ 6.0 mm
5-952	∅ 7.0 mm
5-954	∅ 8.0 mm
5-956	∅ 9.0 mm
5-958	∅ 10.0 mm
5-960	∅ 11.0 mm
5-962	∅ 12.0 mm



Material: Titan ISO 5832 / 03

Total Length / mm	20	25	30
-------------------	----	----	----

Flat Head

∅ 7 mm	5-900	5-902	5-904
∅ 8 mm	5-910	5-912	5-914
∅ 9 mm	5-920	5-922	5-924

Round Head

∅ 7 mm	5-927	5-928	5-929
∅ 8 mm	5-930	5-931	5-932
∅ 9 mm	5-933	5-934	5-935

Cannulated



Cannulated Drill Sleeve

5-970	Drill Sleeve for 5-950
5-972	Drill Sleeve for 5-954
5-974	Drill Sleeve for 5-958
5-976	Drill Sleeve for 5-962